

IMPORTANT SAFETY INSTRUCTIONS  
INCLUDED. READ THROUGH CAREFULLY  
BEFORE YOU RIDE.

*Today*



# Safety Warnings

---

## <About this Manual>

\* This manual contains the information for the correct handling, safe riding and basic maintenance of your motorcycle. Please read through "**Safety Warning**", "**Safe Riding**" and "**Maintenance Safety Tips**" as they are particularly important.

\* Even if you are familiar with motorcycles already, please read this manual as this model has some special features. Please also read the maintenance notes.

\* When re-selling this motorcycle, please hand this manual and the maintenance record to the next owner.

\* Honda Motor Co., reserves the right to alter specifications and make other changes at any time without notice or obligation.

## <Safety Warning>

The following safety warnings are used in this manual to alert you to potential dangers to the rider, passenger and others. Always read the warnings thoroughly.



**Warning:** High Potential for causing death or severe injury.



**Caution:** Potential for causing death or severe injury.



**Note:** Potential for minor injury.

\* Other symbols:



**Advice:** To keep the motorcycle in peak condition.



**Tips:** To ensure best performance and pleasant riding.

# Contents

Safe Riding Tips	4
Features	10
Instruments	12
Speedometer	12
Odometer	12
Instruments	13
Brake System	13
Ignition Switch	13
Switches	14
Starter Switch	14
Hi/Lo Beam switch	15
Indicator Switch	15
Horn Switch	15
Steering Lock	16
Engaging/Disengaging	16
Convenience Hook	16
Seat	17
Boot	18
Helmet Holder	19
Document Holder	20
Brake Lock Lever	21

Refuelling	22
Refuelling Procedure	22
Starting the engine	23
Starting Procedure	24
Kick Start Engine	26
Correct Riding	28
Stopping the M/cycle	30

## STATIONARY NOISE TEST INFORMATION

- TESTED 76.6dB (A) AT 4000 rpm
- SILENCING SYSTEM : HONDA
- IDENTIFICATION : HM GFC K1

NVS503901

Maintenance Safety	.....32
Maintenance Information	.....34
Daily Inspection	.....36
Regular Service	.....38
Brakes	.....40
Adjusting Free Play	.....40
Tyres - Checks	.....42
Engine Oil	.....44
Battery	.....46
Fuses	.....48
Transmission	.....49
Air Filter	.....50
Rubber Boots	.....51
Breather Drain	.....51

Caring for your M/cycle	.....52
Storing your M/cycle	.....53
Environmental	.....54
Coloured Parts	.....54
Genuine Honda Parts	.....54
Identification Numbers	.....55
Number Locations	.....55
Troubleshooting	.....55
Specifications	.....56

# Tips for Safe Riding

Correct Protective Clothing and Helmet are essential for safe riding. Observe road regulations and never speed, for your own safety.

Topics covered in the following pages are some basic instructions for your daily handling of this motorcycle. Again, these are for your own safety.

An overspeed warning light is installed on this vehicle. This is fitted for other markets and is not applicable to Australia - Please disregard.

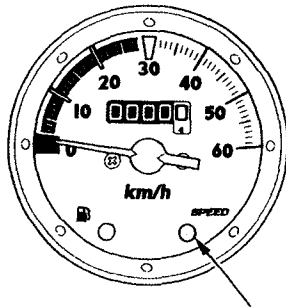

Overspeed warning Light

The maximum capacity of this vehicle is one person. Carrying a pillion passenger is prohibited.

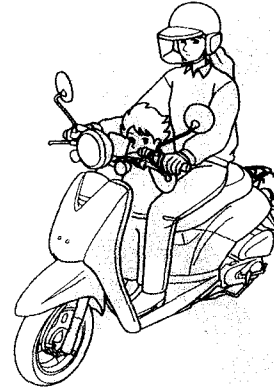

## Before Riding

Please carry out a daily inspection and keep the vehicle clean. See page 34 for details of the daily inspection.

Also, you should arrange a regular maintenance check. For details, see page 36.

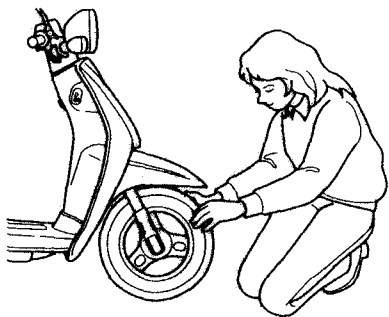

Always stop the engine and keep away from flames, or other possible ignition sources when refuelling.

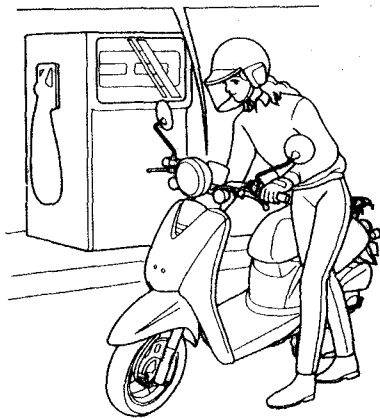
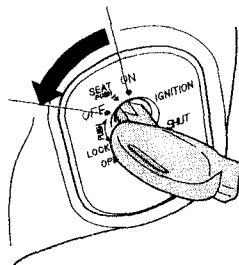

Exhaust fumes contain carbon monoxide and other toxic gas. It is essential that the engine is run only in a well ventilated place.



## Tips for Safe Riding

It is required by law for all riders to wear a helmet when riding a motorcycle. It is vital that you wear a helmet properly and that the helmet is approved to Australian Standard AS1698.

Wearing protective gear and clothing is strongly recommended, such as:

- face shield or goggles
- footwear which covers up to the ankles.
- strong leather gloves
- long sleeved jacket and long trousers.

in terms of clothing, we recommend:

- bright coloured and allow ease of movement.
- avoid wide open cuffs as they may interfere with brake lever operations.

### WARNING

It is vital that you wear a helmet properly, to reduce the risk of fatal or serious injury in the event of an accident. It is also essential that your helmet fits you correctly.

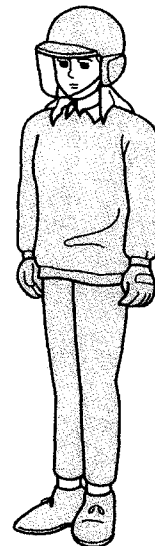



## Riding Position

---

When riding, always use both hands to hold the handlebar and keep your feet firmly on the floor.

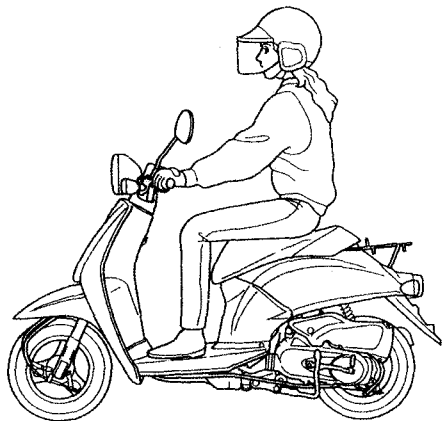

Always avoid abrupt steering movements and single-handed riding. These are basic safety rules and may cause you to lose control of the motorcycle.

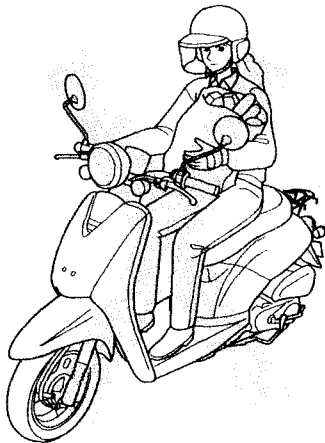

# Loading

Loading of cargo changes the feel and handling of the motorcycle. Overloading may result in dangerously unstable steering.

The correct load limits are shown below:

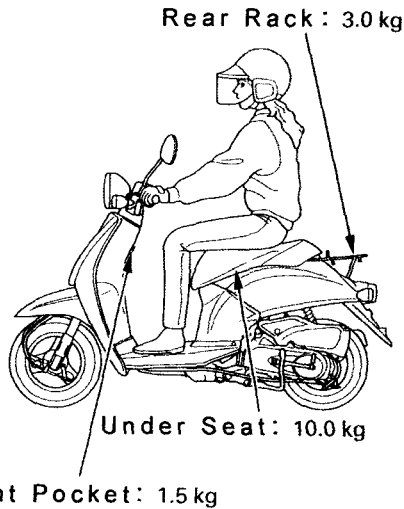

- Please do not hang large items on the convenience hook as they may interfere with the steering.
- Objects placed near the handlebar may interfere with the steering. Keep the area well clear at all times.
- Do not obstruct the head light with any object. The heat from the light may melt the lens or the object.
- Do not put heavy objects in the Under Seat storage area as they may damage the inner surfaces.
- Do not load objects in anywhere other than the designated carrying areas, as the vehicle may be damaged or become unstable.

## Modification:

Modifications affecting the vehicle structure or its performance may change the vehicle controllability or its handling characteristics. Such modifications are illegal and may reduce the life of the product.

Also, it should be noted that modifications to the motorcycle may affect the Warranty.

This motorcycle complies with the latest Australian Noise Emissions regulations. Any modification affecting the Noise Control Systems are prohibited and may render the motorcycle unroadworthy.

## Parking the Motorcycle

In order to prevent your motorcycle being stolen, always lock the steering when leaving your motorcycle unattended. Always close the Ignition Lock protector when leaving the motorcycle unattended.

- Always park the motorcycle on a firm, flat surface.
- Always select a parking area that does not interfere with traffic flow.
- If there is no other choice but to park on a rough, sloped or soft surface, take necessary precautions to prevent the motorcycle from moving or tipping over.

- The exhaust pipe is very hot for some time after the engine is stopped. Please take necessary precautions when parking.

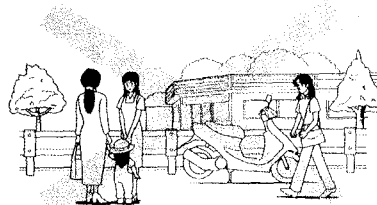
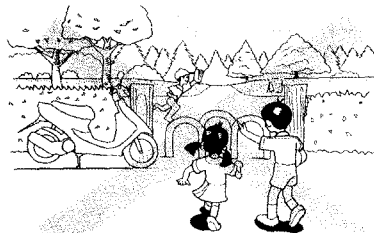

- For your safety, do not touch the engine or exhaust pipe while the engine is running, and for some time after the engine is stopped.

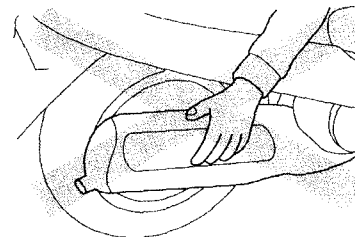

### WARNING

The engine and exhaust are very hot when the engine is running, and for some time after the engine is stopped. In order to avoid burn injury:

- Do not touch the engine or exhaust while the engine is running or soon after it has been stopped.
- Park the motorcycle so as to keep hot components away from other people.

# Features

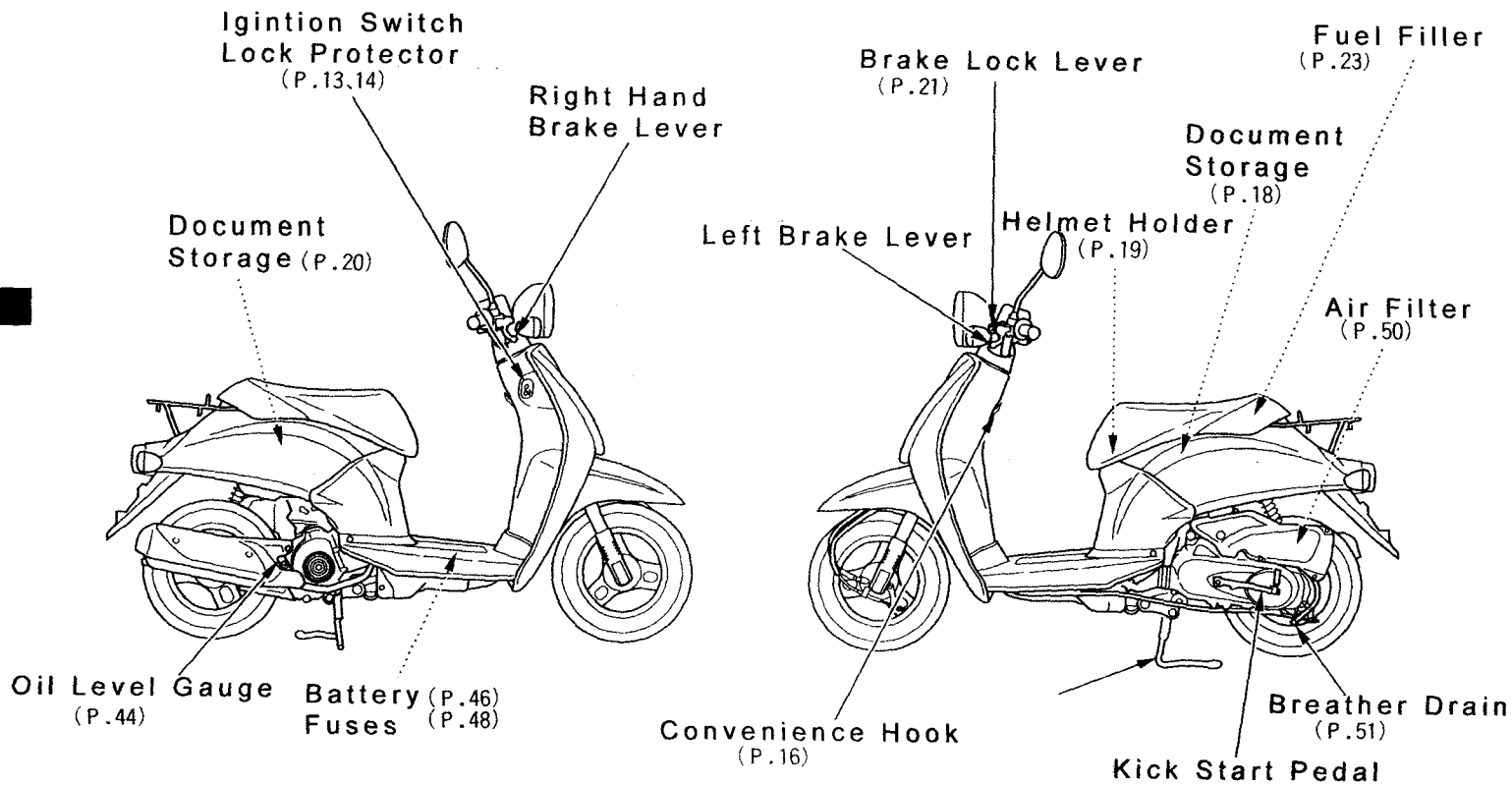

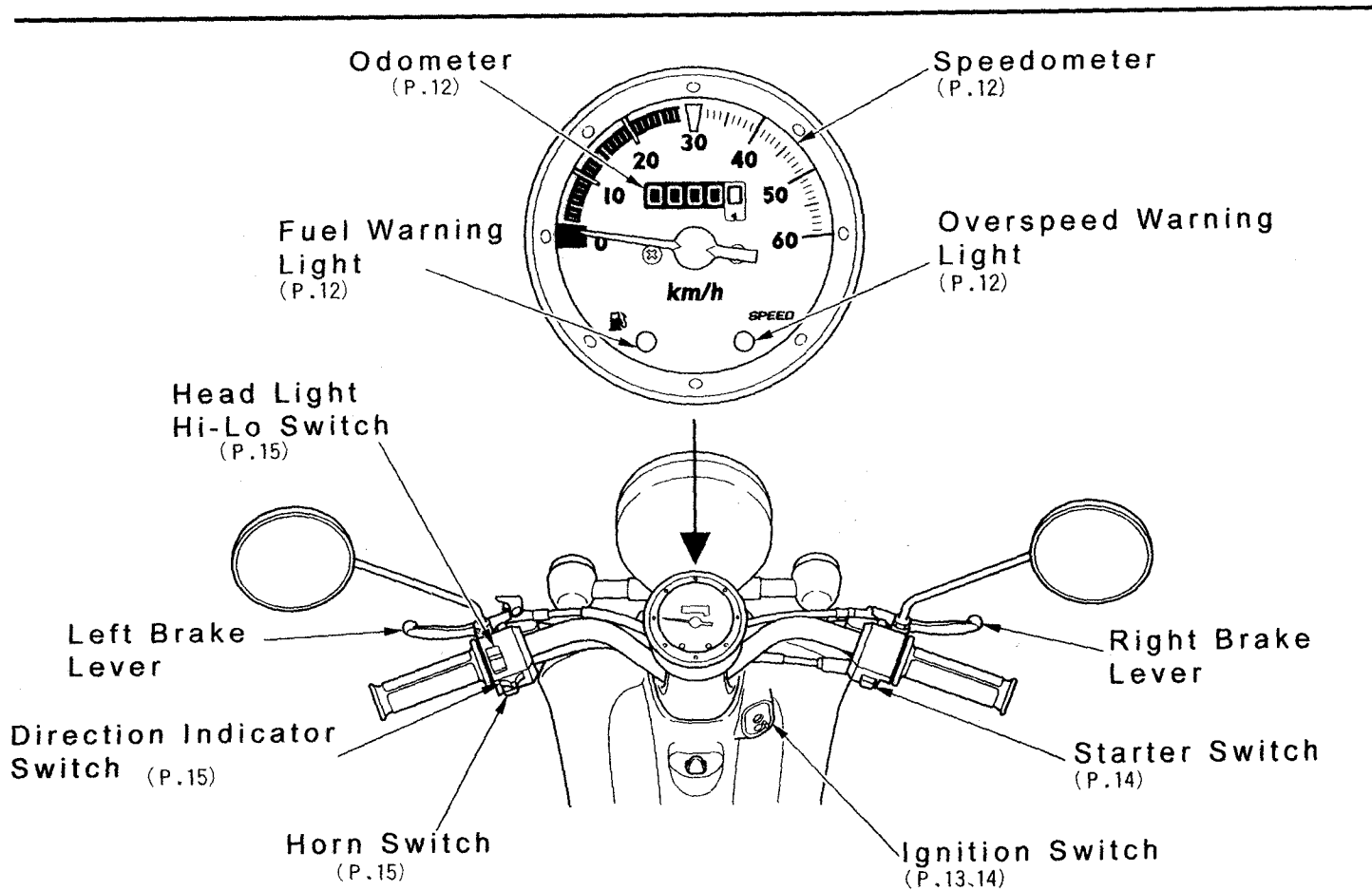

# Instruments

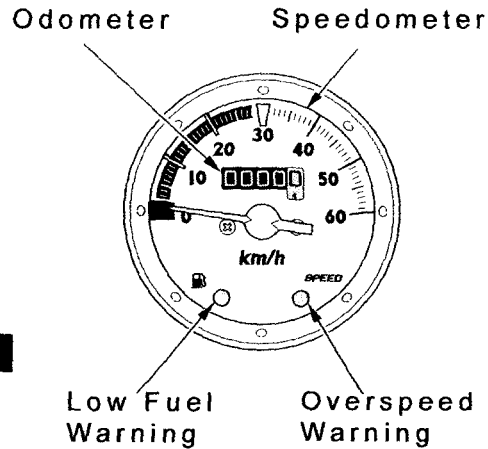

## Speedometer

Indicates the vehicle speed in Km/h. Always observe the local speed limit.

## Odometer

Displays the cumulative distance travelled in km's. The last digit with white background indicates in 100 metre. The fourth digit, 1000km, has Amber background at 1,3,6&9. We recommend at least an oil change at these intervals.

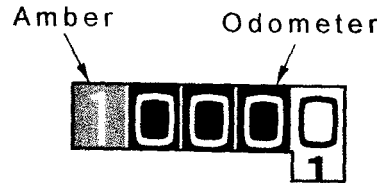

## Overspeed Warning

This will flash when the vehicle speed exceeds 30kph.

## Low Fuel Warning

Indicates that the fuel quantity is Low. You should refuel as soon as possible if the Low Fuel Warning illuminates, which indicates that you have 1litre of fuel remaining in the fuel tank.

# Instruments

## Coupled Braking System

- The Left Brake Lever controls both the Front and Rear wheel brakes.

- The Right Brake Lever controls the Front wheel brakes only.

For most effective Braking, use both the Left and Right Brake levers at the same time.

## Ignition Switch

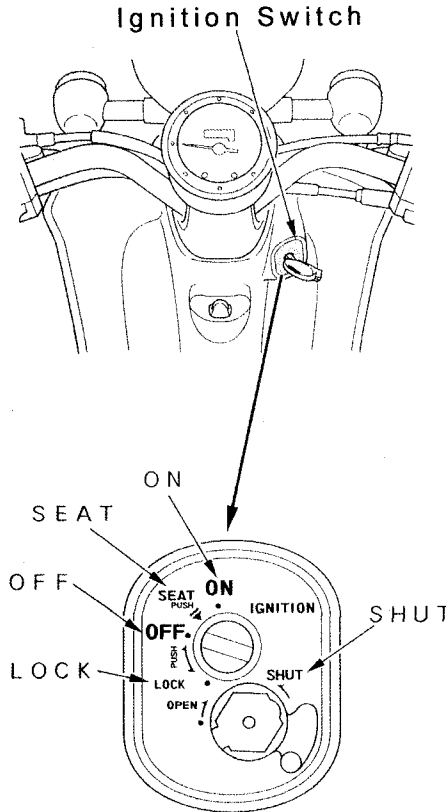

LOCK ...The Ignition key can be removed.

OFF ..... Engine is stopped. The Ignition key can be removed.

SEAT ... Seat can be opened. The engine cannot be started. Key is locked in.

ON ..... The engine can be started. The Key is locked in.

SHUT ... The lock protector is Shut. (See next page.)

### Tip

- Leaving the Ignition key in the "ON" position for long periods, with the engine stopped will cause the battery to go flat.

# Switches

## Lock Protector

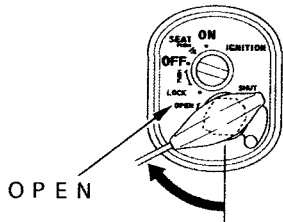
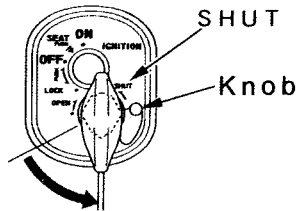
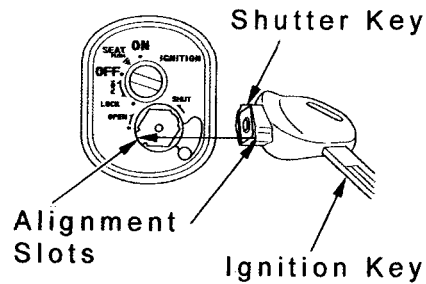

The Lock Protector is designed to help prevent theft. This should be shut whenever the motorcycle is left unattended.

### <Closing the Shutter>

Pull out the ignition key and insert the Shutter key. Turn it counterclockwise until the shutter closes.

### <Opening the Shutter>

Insert the shutter key and turn it clockwise until the shutter opens.

The Shutter Key is moulded as part of the Ignition Key. It is not a separate key.

## Starter Switch

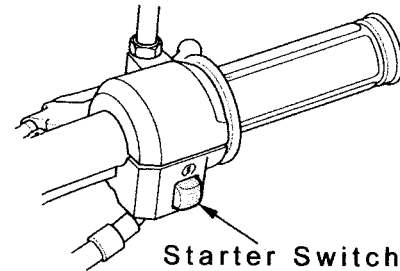

Turn the Ignition key to "ON" and apply the brakes. Push the starter switch to start the engine.

### Tip:

- The engine will not start unless brake is applied.



## Hi/Lo Beam Switch

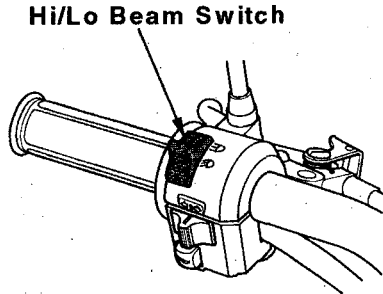

- ☞ ... Move the switch to this position for Hi Beam.
- ☞ ... Move the switch to this position for Lo Beam.

**Always select Lo Beam when Other traffic is approaching.**

## Indicator Switch

Indicator Switch

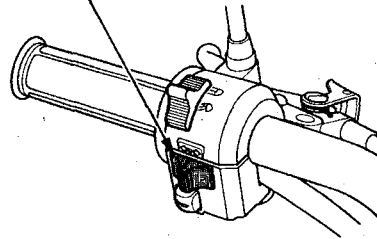

The Indicator can be selected by moving the switch to the left or right.

- ☞ ... Move the switch to the Right for Right Hand Turn.
- ☞ ... Move the switch to the Left for Left Hand Turn.

### Tip:

The Indicator does not self Cancel. After turning you must return the switch to the "OFF" position.

## Horn Switch

Horn Switch

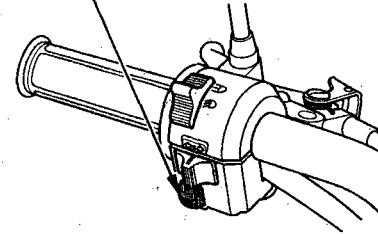

The Horn is activated by pressing the Horn Switch. The Horn will sound as long as the switch is **depressed**.

# Equipment

## Steering Lock

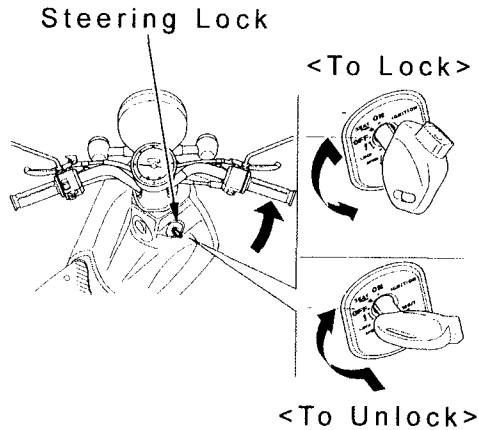

Always apply the Steering Lock whenever you leave the motorcycle unattended. We also recommend using chain locks in addition to this feature.

### <Engaging the lock>

Turn the Handlebar fully to the left, push in and turn the ignition key from "OFF" to "LOCK". Jiggle the handlebar if the lock does not engage immediately.

### <Disengaging the Lock>

Push in and turn the Ignition key from "LOCK" to "OFF" position.

#### Tip:

- After engaging the lock, check that it has engaged by trying to turn the bars.
- Park in an appropriate area so your m/cycle does not obstruct traffic.

## Convenience Hook

### Convenience Hook

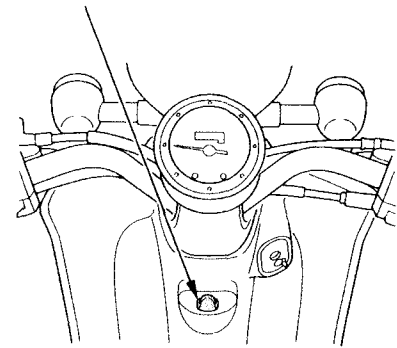

Maximum capacity of the Convenience Hook is **1.5kg**.

Please do not suspend large items on the Convenience Hook. The items should be small enough not to stick out of the vehicle or interfere with your steering.

## Seat

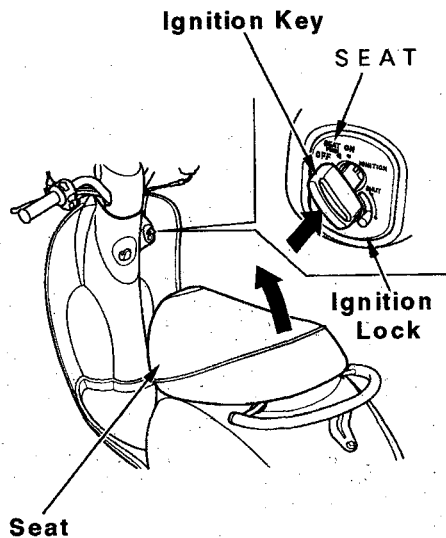

### To Open:

1. Insert the Ignition key into the Ignition Lock and turn it to the "SEAT" position. Push the Ignition key to release lock and open Seat. The seat can now be lifted up to open.

### To Close:

Lower the Seat and press down firmly on the Rear section of the seat to lock it. Riding when the Seat is not properly locked can cause interference/impered riding.

### Tip:

Once the seat is locked into position, it cannot be opened without the key. Take care to ensure that you do not lock the key under the seat.

# Equipment

## Boot

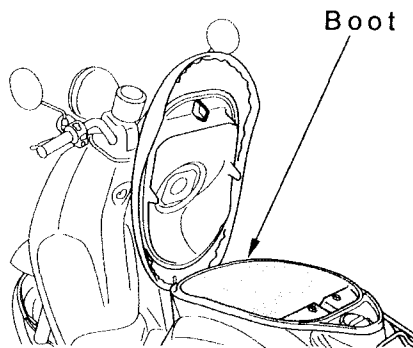

### Maximum Loading 10.0kg

- The seat can be opened by releasing its lock with the Ignition key. (Pg17).
- \_ After closing the Seat, make sure it is locked. Riding with the Seat unlocked is very dangerous.

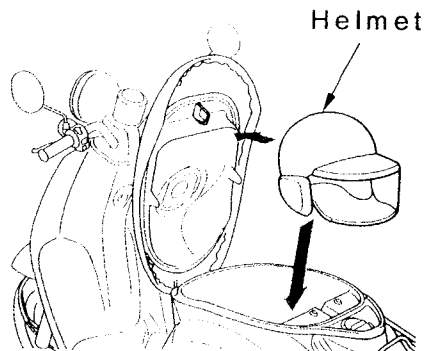

Your helmet can be stored in the boot by facing it towards the rear of the motorcycle.

### Tip:

- Make sure that the ignition key is not left inside the boot when closing it. The boot cannot be opened without it.
- \_ The temperature inside the Boot may increase due to engine heat. Do not put food or flammable items in the boot.
- \_ Do not put fragile or valuable items in the boot.
- \_ The boot is not fully waterproof.
- \_ Depending on size and shape, some helmets and boots may not fit in boot.

## Helmet Holder

Helmet Holder

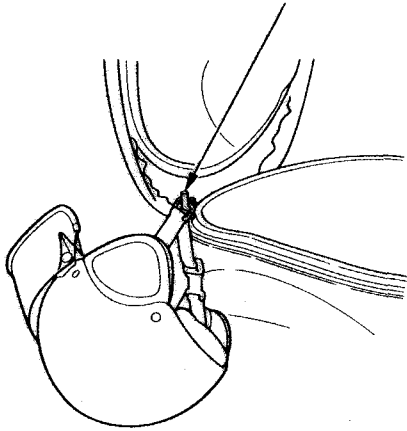

The Helmet holder is only meant to be used when the motorcycle is parked.

When riding, the helmet may disturb your riding and may damage the motorcycle and the helmet itself.

### <Suspending the Helmet>

1. Open the Seat (Pg17).
2. Hook the helmet strap buckle to the helmet holder.
3. Lower the seat and lock it by pushing down firmly on the rear section of the seat. Make sure the seat is properly locked in place.

### <Removing the Helmet>

Use the Ignition key to open the seat and remove the helmet from the hook.

### Tip:

Make sure the Ignition key is not left in the boot when closing it. The boot cannot be opened without it.

## Features

### Document Holder

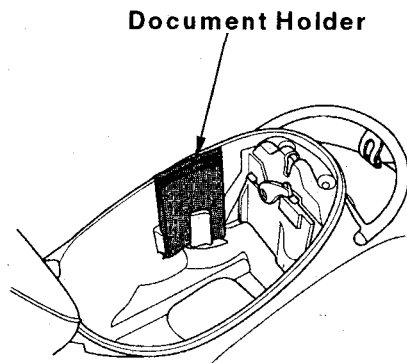

To access the Document Holder, lift the Seat as per the procedure on page17 of this manual.

## Brake Lock Lever

Brake Lock Lever

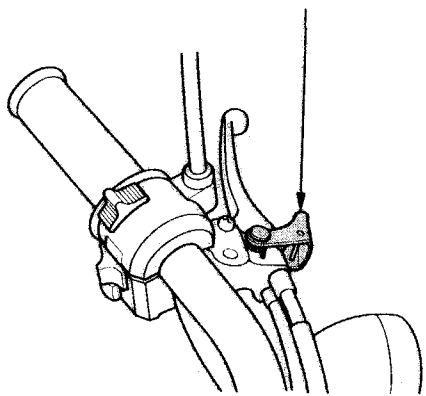

### Tip:

The Brake cannot be locked if the Rear Brake is not adjusted in accordance with the specification. (Pg38).

### <Locking the Brake>

1. Firmly grasp the left brake lever.
2. Move the Brake Lock lever in the direction shown in the diagram below and lock it in position.
3. Release the Left brake lever. The rear brake is now locked.

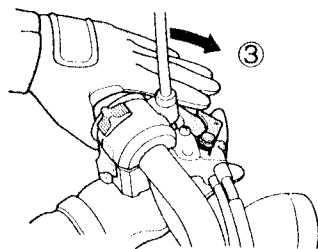
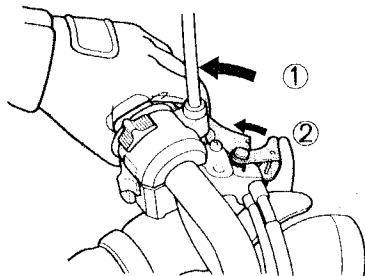

### <Unlocking the Brake>

1. Firmly grasp the left brake lever. The lock lever will disengage automatically.
2. Release the Left brake lever. The Rear brake is now disengaged.

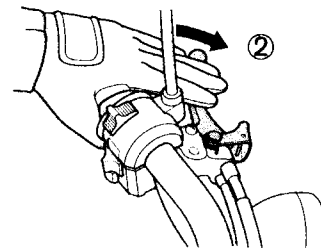
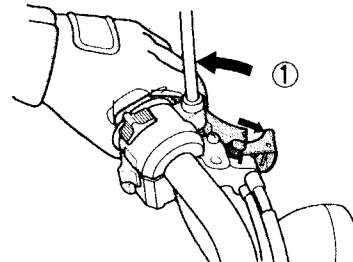

## Refuelling

Type of Fuel: Unleaded  
Petrol only.

### Advice:

- Always use only Unleaded Petrol when refuelling.
- Using fuels containing high levels of alcohol can cause engine or fuel system damage.
- Diesel, inferior petrol or inappropriate fuel additives can adversely affect the engine.

### Warning

- Always stop the engine and keep away from naked flame, sparks or other possible ignition sources when refuelling.
- Refuelling should only be carried out outdoors.
- Spilt petrol should be wiped up immediately.
- Sparks arising from a build-up of static electricity around the body can ignite petrol vapour and cause burn injuries.

#### When Refuelling:

- Eliminate static electricity around the body, before opening the fuel tank cap, by touching metal areas such as the motorcycle body or filler nozzle.
- Only allow refuelling by a person who has eliminated static electricity.



### <Refuelling>

1. Open the Seat (Pg17)
2. Turn the Fuel tank cap to the left to open it.
3. Fill with petrol to the bottom end of the level plate inside the filler neck.

Filling the tank above the bottom end of the filler neck may cause petrol to spill from the fuel tank cap breather.

4. Turning the fuel tank cap to the right closes it. Turn the cap firmly until the Triangular mark on the tank cap aligns with the Triangular mark on the fuel tank surface.
5. Lower the seat and press firmly on the rear of the seat to lock it. Confirm that it is locked.

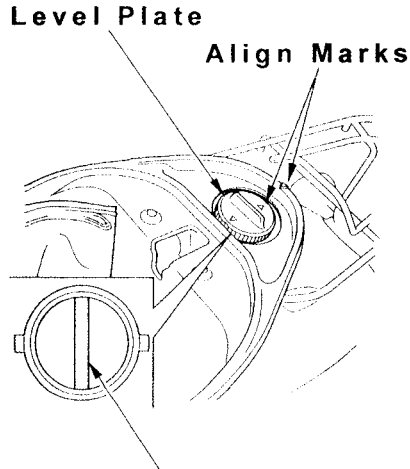

## Procedures

### <Starting the engine>

Exhaust fumes contain carbon monoxide and other toxic gases. It is essential that the engine is run only in a well ventilated area.

Please follow the procedures on Pages 23~25 to start the engine.

- Prior to starting the engine check the oil and fuel levels (See Pg34).
- Use the mainstand when starting the motorcycle.
- Make sure the Rear Brake is Locked when starting the engine to prevent the motorcycle jumping forward. The Rear Brake cannot be locked if it is not adjusted correctly. (See Pg38 for Rear Brake adjustment procedure).

### <Starting Procedure>

1. Lock the Rear Brake (Pg21).

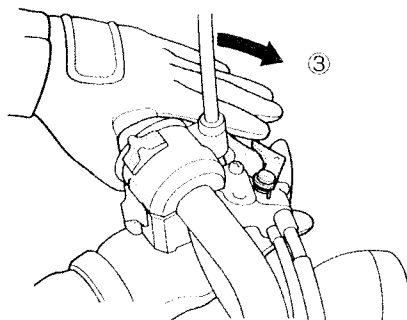
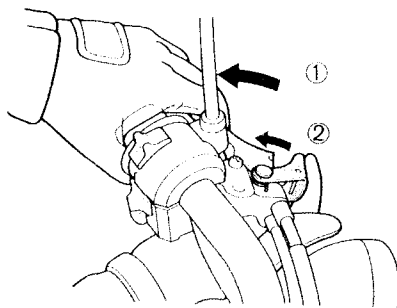

2. Turn the ignition switch to "ON".

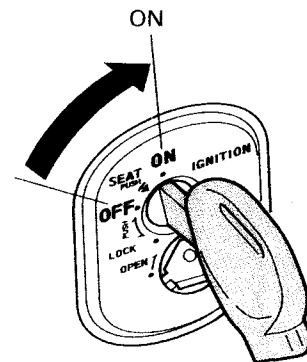

- ③ Press the Starter Button without opening the Throttle.

Release the Starter as soon as the engine starts.

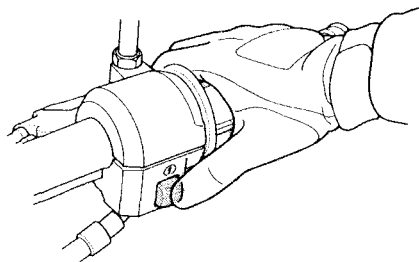

 **Advice:**

- Do not press the Starter Button when the engine is running.

If the engine is warm and fails to start after using the starter for 3~4 seconds, open the Throttle  $1/8 \sim 1/4$  turn.

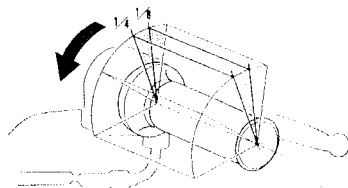

It may take longer than usual to start the engine after not using the motor-cycle for a long time, or after refuelling when you have run out of fuel. The Throttle should be fully closed. To save the battery, do not use the starter for longer than 15 seconds and allow 10 seconds between each attempt.

- ④ If the engine is cold, warm up for a few minutes after starting the engine.

 **Advice:**

\* Avoid prolonged warm-up. It not only wastes fuel, but it can be harmful to the engine.

## Procedures

### <Starting the engine with the Kick Starter>

After Step 2, kick the Starter Pedal without opening the Throttle.

Once the engine starts, retract the Starter Pedal before riding.

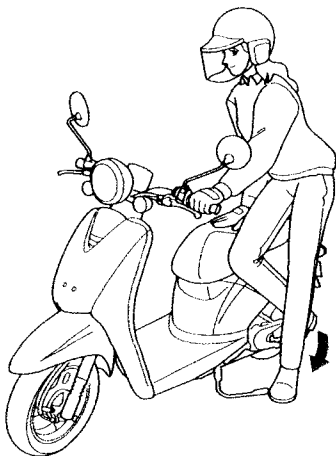

If the engine is warm and fails to start after using the Starter Pedal for 3~4 Seconds, open the Throttle for 1/8~1/4 turn.

You may find it difficult to start the motorcycle after not using for a long time or when refuelling when you have run out of fuel. The throttle should be fully closed and it may take a few attempts to start the engine.

### <Starting to ride>

- Take the motorcycle off the support stand.
  - Push the motorcycle forward to take it off the support stand.
- Make sure the Rear Brake lock is fully engaged and keep the engine running at low rpm.

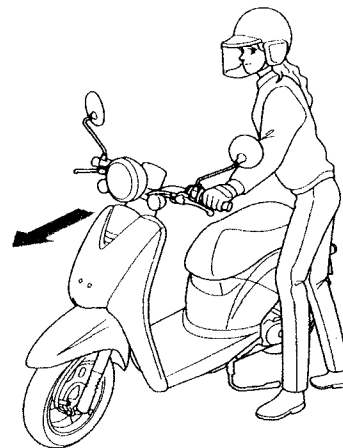

② Mounting the motorcycle.

- Mount from the left side of the motorcycle. Sit on the seat and balance yourself by keeping one foot firmly on the ground.

Keep the Brake Lock engaged.

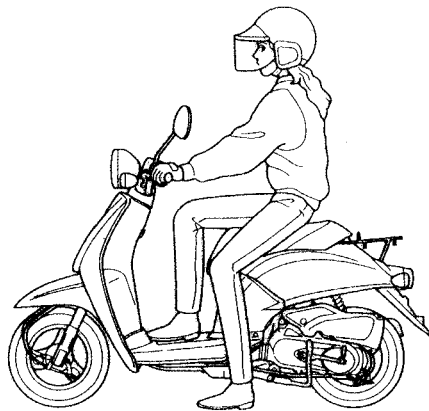

- ③ Grasp the Left Brake Lever to release the Brake Lock.

Do not open the Throttle while releasing the Brake Lock or the motorcycle will jump forward.

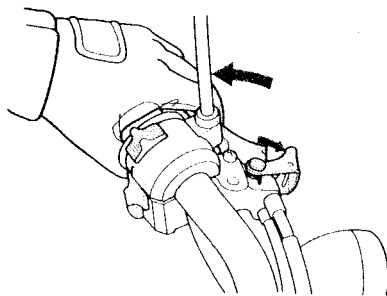

- ④ Release the left brake lever and slowly open the throttle.

Avoid rapid throttle opening to prevent the motorcycle accelerating too fast.

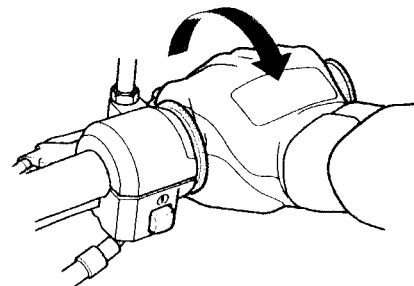

## Correct Riding

Before starting to ride the motorcycle, turn on the Direction Indicator and check behind. Checking behind is best done by looking in the rear view mirrors and then over your shoulder.

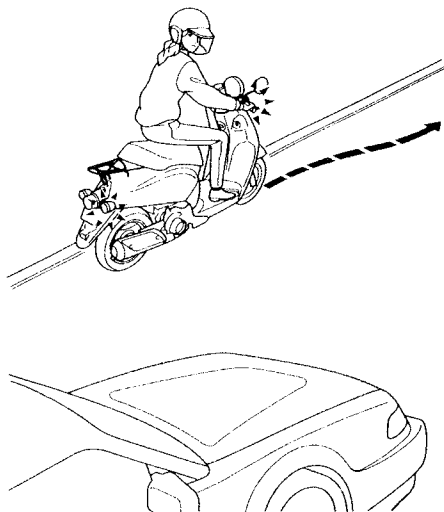

The vehicle speed can be controlled by the throttle grip.

**OPEN** - Increase the speed. Open the throttle slowly. Gradually open the throttle when going up hill.

**CLOSE** - Reduce the speed. Close the throttle quickly to reduce speed.

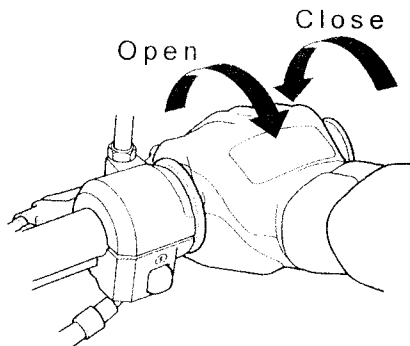

When using the brakes, use both left and right brake simultaneously.

- Use the brakes only after closing the throttle.

- Apply brakes gently, at first, and then firmly.

Never operate the Brake Lock Lever when riding. Sudden locking of the brakes is extremely dangerous.

Left Brake

Right Brake

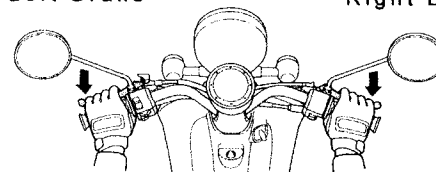

Avoid unnecessarily heavy braking. Abrupt braking may lock the wheels and cause you to lose control of your motorcycle.

Tyres can slip on wet surfaces and your brake-stop distance increases. Slow down and apply brakes earlier.

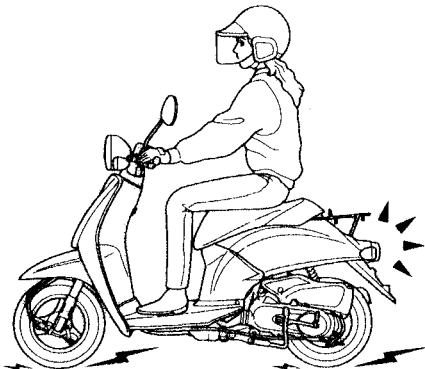

Extra caution is required when riding on a rainy day.

- Tyres may slip on a wet surface and your braking distance may increase. Slow down and apply brakes earlier.

- Close the throttle when going downhill and apply brakes to control speed.

- Continuous braking may lead to brake overheating.

- Braking performance may drop after riding through water or on rainy days.

Find a safe area and check brake operation. If the performance is poor, ride at a slow speed while gently applying the brakes to "dry" the brakes.

- Snowy or icy surfaces are more slippery. Slow down when riding on these surfaces.

### <Stopping the motorcycle>

1. When you approach the stopping position:

- Turn on the Direction Indicator in advance, to warn other traffic of your intentions. Move to the left hand side of the road and stay to the left.

- Close the throttle and apply both brakes simultaneously. The brake light will illuminate to warn other vehicles.

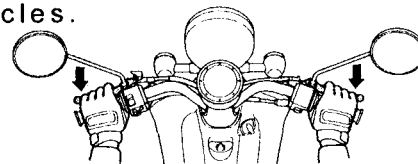

Left Brake

Right Brake

2. When the motorcycle has stopped:

- Cancel the Direction Indicator and turn the Ignition off to stop the engine.

Do not touch the ignition key while riding. The ignition system does not operate in the "SEAT", "OFF" or "LOCK" positions.

Unintentionally turning off the ignition while riding is very dangerous. Stop the motorcycle if you need to turn the ignition key.

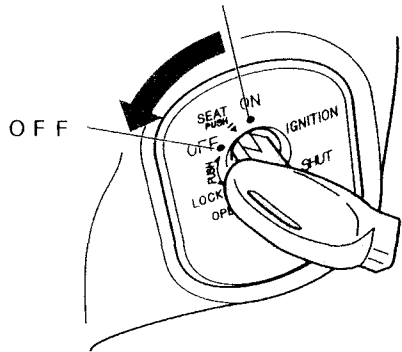

3. Get off to the left and put the motorcycle on the support stand, on level ground.

- Find a safe place with firm, flat surface.  
- Hold the handlebar straight with your left hand and hold the rear rack with your right hand. Pull back as you push the support stand down with your foot.

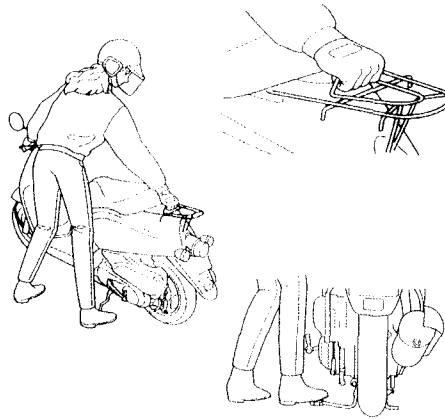

4. In order to prevent theft, always apply the steering lock, remove the ignition key and close the Lock Protector.

We also recommend using a chain and lock in conjunction with these features.

Please be considerate when selecting a place to park your motorcycle.

NOTE: Appropriate Run-in procedures will extend the life of your motorcycle. Please avoid rapid acceleration and braking for the first 100km's.



## For your Safety

---

Always stop the engine and remove the ignition key before starting any maintenance work.

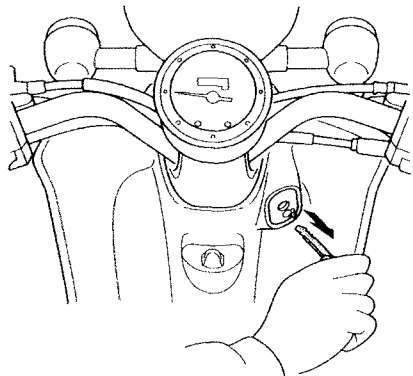

All maintenance should be carried out on a clean, flat and solid surface.

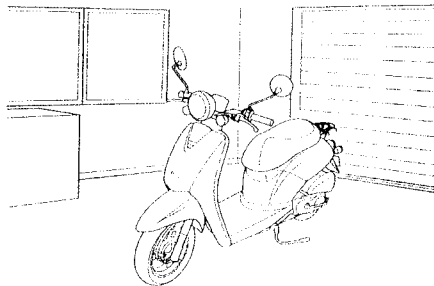

The engine, muffler and the exhaust pipe are very hot when the engine is running and for some time after it is turned off.

Use caution when carrying out any maintenance near these components.

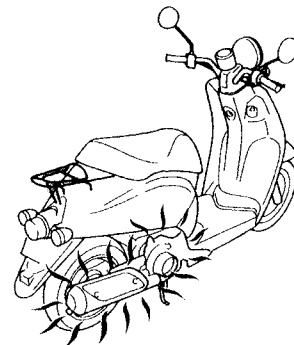

Exhaust fumes contain dangerous gases, like Carbon Monoxide, which can be fatal. Never run the engine in an enclosed space.

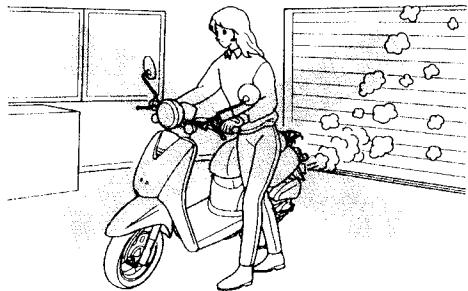

If the motorcycle requires test riding, do so in a safe manner and obey all traffic regulations.

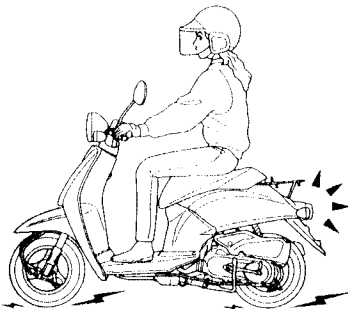

Always use the correct tools when carrying out any maintenance or repairs on the motorcycle.

Any servicing, repair or adjustment should be carried out by an authorised Honda Dealer.

For your safety, we have provided a service schedule for your motorcycle. This is a very basic, minimum service recommendation and your authorised Honda dealer is best placed to advise you on the best service for your motorcycle.

**Warning**

Failure to carry out appropriate servicing may cause an accident and result in serious or fatal injury. It may also void your warranty.

- Please discuss your servicing needs with a Honda dealer.
- Defects found during riding should be rectified prior to your next ride.

Please ensure that you have your motorcycle serviced and maintained regularly.

Please refer to the following pages for details of servicing requirements:

One Month Check .....	35
Spare Parts .....	35
Daily Inspection .....	36
Parts Layout .....	37
Regular Service .....	38
Six Month Service .....	39
Basic Maintenance .....	40
Brakes .....	40
Tyres .....	42
Engine Oil .....	44
Battery .....	46
Fuses .....	48
Transmission .....	49
Air Filter .....	50
Cables .....	51
Breather Drain .....	51

### <One Month Check>

This check is to be carried out at one month or 1000km, after initial purchase, whichever occurs first. This inspection and adjustment can significantly affect the life of the motorcycle.

This service should be carried out by the authorised Honda dealer from whom you purchased the motorcycle. Replacement oil and any parts used will be charged to you.

Please refer to your Owner's Warranty Policy and Service Record booklet for information on your Warranty obligations.

### <Spare Parts>

Always use genuine Honda parts for replacement or service. We guarantee the quality and compatibility for your motorcycle.

Please contact your Honda dealer for purchasing any parts required.

All genuine Honda parts, with the Logo shown below, are covered by a Honda factory warranty.

# HONDA

GENUINE PARTS

## <Daily Inspection>

This is a quick inspection that you should carry out on a daily basis, prior to riding the motorcycle. Please carry out this inspection for your own safety and comfort.

Items shown on the right should be inspected daily. The opposite page shows the location of inspection items, for your reference.

Please refer to your Honda dealer if you encounter any problems, or are unsure of how to check any of these items.

## <Inspection Items>

Brakes	Lever Free Play Braking Performance
Tyres	Air Pressure Cuts and other damage Unusual wear Tread depth
Engine	Oil Level Starting / Noise. Low Speed / Accelleration

Lights and Indicators

Any Defects noticed during riding.

Items such as Tyre Tread, Oil Level, Noises & Performance issues should be inspected at regular intervals, based on riding habits and distance.